

**SPECIFICATION
FOR
CTP Module
KDCTP030001A**

MODULE:	KDCTP030001A
CUSTOMER:	

REV	DESCRIPTION	DATE
1.0	FIRST ISSUE	2015.07.13

STARTEK	INITIAL	DATE
PREPARED BY		
CHECKED BY		
APPROVED BY		

CUSTOMER	INITIAL	DATE
APPROVED BY		



Revision History

Date	Rev. No.	Page	Summary
2015.07.13	V1.0	ALL	FIRST ISSUE

Contents

General Description	-----4
1. Outline dimension	-----5
2. Input Terminal Pin Assignment	-----6
3. Electrical Characteristics	-----7
4. AC Characteristic	-----8
5. Appearance limit standard	-----9
6. Reliability Specification	-----13
7. Handling Precautions	-----14
8. Packing	-----15

General Description

* Description

This is a Projective CTP(Capacitive Touch Panel) which shall apply to metal pen or finger input. This model is composed of a Cover Lens, ITO Sensor, Driver circuit, OCA and Foam. This CTP is suitable for a 3.0'TFT(Thin Film Transistor) LCD(liquid crystal display), and the view area of the CTP shall be a little more than the display area of TFT-LCD.

* Features

- Low Input Voltage: 2.8V~3.3V(TYP)
- view area of CTP: 39.84(H)*66.00(V)
- Interface: I2C

General Information Items	Specification	Unit	Note
	Main Panel		
View Area (VA)	39.84(H)*66.00(V) (3.0inch)	mm	-
Transparency	≥86%		-
Haze	<3%		
screen	22		-
Hardness	≥6H	-	-
Driver IC	FT6236	-	-
Interface	I2C		
Touch type	Projective Capacitive	-	-
Touch mode	Single point and Gestures		
Structure	G+G(Cover Glass + ITO Glass)		
Operating temperature	-20~+70	°C	-
Storage temperature	-30~+80	°C	-

* Mechanical Information

Item		Min.	Typ.	Max.	Unit	Note
Module size	Horizontal(H)		51.04		mm	-
	Vertical(V)		88.60		mm	-
	Depth(D)			2.0	mm	-
Weight			TBD		g	-

1. Outline dimension

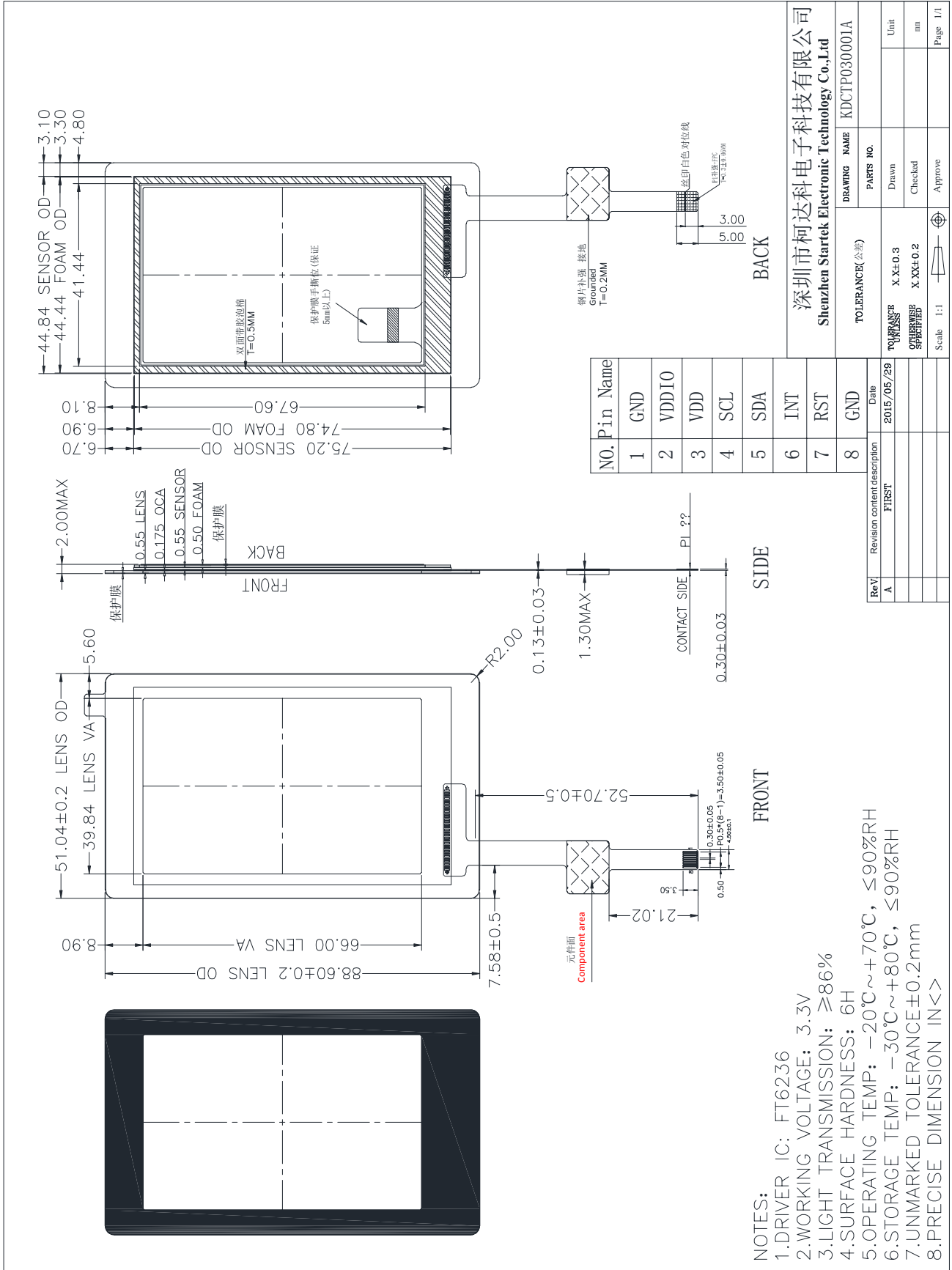

2. Input terminal Pin Assignment

NO.	SYMBOL	DISCRIPTION	I/O
1	GND	Ground.	P
2	VDDIO	I/O power supply voltage.	P
3	VDD	Supply voltage.	P
4	SCL	I2C clock input.	I
5	SDA	I2C data input and output	I/O
6	INT	External interrupt to the host.	I
7	RST	External Reset, Low is active.	I
8	GND	Ground.	P

3. Electrical Characteristics

3.1 Absolute Maximum Rating

Item	Symbol	Min.	Max.	Unit	Note
Power Supply Voltage	VDD	-0.3	3.6	V	1
I/O Digital Voltage	VDDIO	1.8	3.6	V	1
Operating temperature	T _{OP}	-20	+70	°C	-
Storage temperature	T _{ST}	-30	+80	°C	-

NOTES:

1. If used beyond the absolute maximum ratings, FT6236 may be permanently damaged. It is strongly recommended that the device be used within the electrical characteristics in normal operations. If exposed to the condition not within the electrical characteristics, it may affect the reliability of the device.

3.2 DC Electrical Characteristics (VDDA=2.8~3.6V, Ta=25°C)

Item	Symbol	Condition	Min.	Typ.	Max.	Unit	Note
Digital supply voltage	VDD		2.8	3.3	3.6	V	
I/O Digital supply voltage	VDDIO		1.8	3.3	3.6	V	
Normal operation mode Current consumption	I _{opr}	VDD=2.8V Ta=25°C MCLK= 17.5Mhz	-	4	-	mA	
Monitor mode Current consumption	I _{mon}		-	1.5	-	mA	
Sleep mode Current consumption	I _{slp}		-	50	-	uA	
Level input voltage	V _{IH}		0.7V _{DDIO}	-	V _{DDIO}	V	
	V _{IL}		-0.3	-	0.3V _{DDIO}	V	
Level output voltage	V _{OH}	I _{OH} =-0.1mA	0.7V _{DDIO}	-	-	V	
	V _{OL}	I _{OH} =0.1mA	-	-	0.3V _{DDIO}	V	

4. AC Characteristics

Table 4-1 AC Characteristics of Oscillators

Item	Symbol	Test Condition	Min	Typ.	Max	Unit	Note
OSC clock 1	fosc1	VDDA= 2.8V; Ta=25°C	34.65	35	35.35	MHz	

Table 4-2 AC Characteristics of sensor

Item	Symbol	Test Condition	Min	Typ.	Max	Unit	Note
Sensor acceptable clock	ftx	VDDA= 2.8V; Ta=25°C	0	100	300	KHz	
Sensor output rise time	Ttxr	VDDA= 2.8V; Ta=25°C	-	100	-	nS	
Sensor output fall time	Ttxf	VDDA= 2.8V; Ta=25°C	-	80	-	nS	
Sensor input voltage	Trxi	VDDA= 2.8V; Ta=25°C	-	5	-	V	

4.1 I2C Interface

The I2C is always configured in the Slave mode. The data transfer format is shown in Figure4-1:

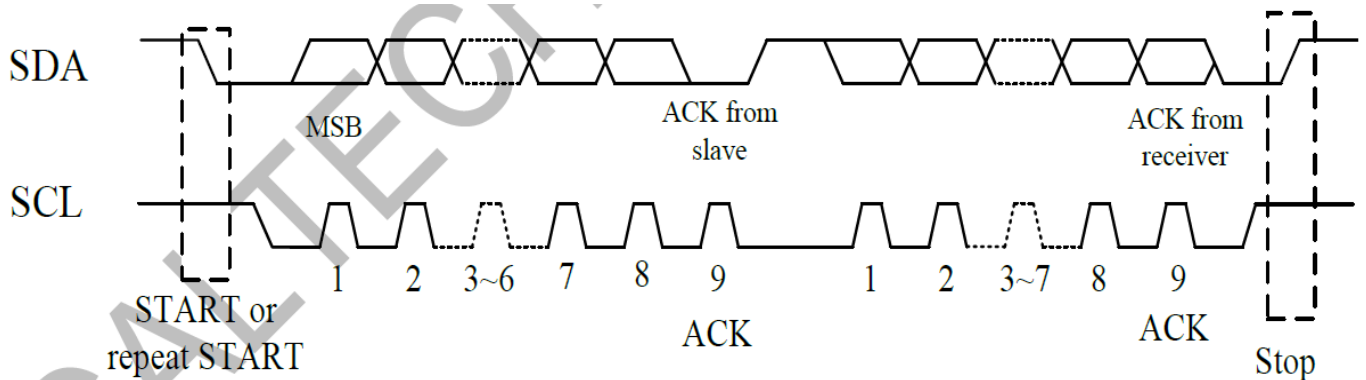

Figure 4-1 I2C Serial Data Transfer Format

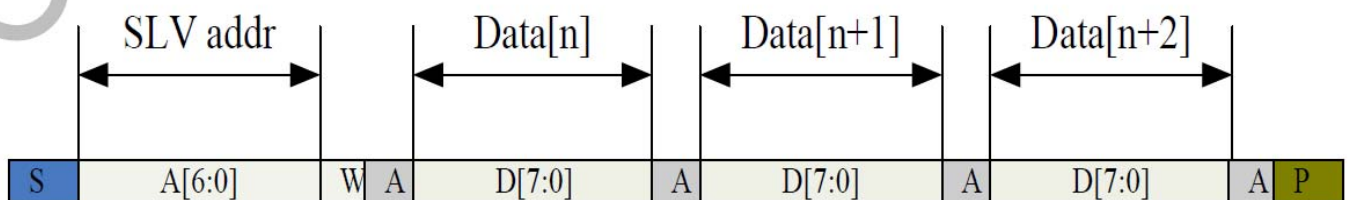

Figure 4-2 I2C master write, slave read

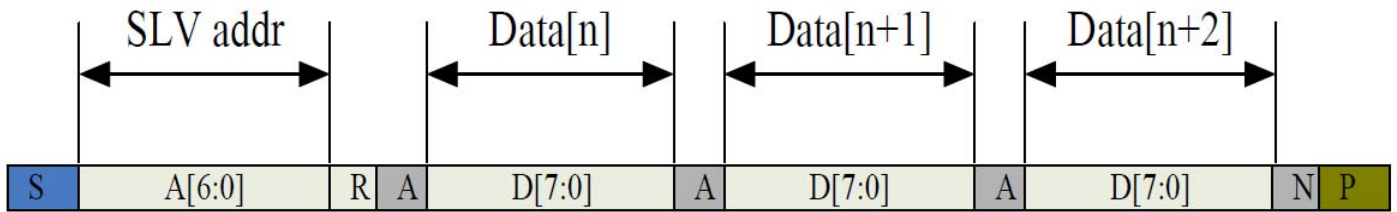

Figure 4-3 I2C master read, slave write

Table4-3 lists the meanings of the mnemonics used in the above figures.

Table 4-3 Mnemonics Description

Mnemonics	Description
S	I2C Start or I2C Restart
A[6:0]	Slave address
R/W	READ/WRITE bit, '1' for read, '0' for write
A(N)	ACK(NACK)
P	STOP: the indication of the end of a packet (if this bit is missing, S will indicate the end of the current packet and the beginning of the next packet)

I2C Interface Timing Characteristics is shown in Table4-4.

Table 4-4 I2C Timing Characteristics

Parameter	Min	Max	Unit
SCL frequency	10	400	KHz
Bus free time between a STOP and START condition	4.7	\	us
Hold time (repeated) START condition	4.0	\	us
Data setup time	250	\	ns
Setup time for a repeated START condition	4.7	\	us
Setup Time for STOP condition	4.0	\	us

5. Appearance limit standard

5.1 Scope

Touch panel visible side.

5.2 Inspection Conditions

1. The brightness in text site: 500LUX.
2. Inspection distance: 30cm.
3. Visual angle: $>60^\circ$.
4. Light source: 40W natural light.

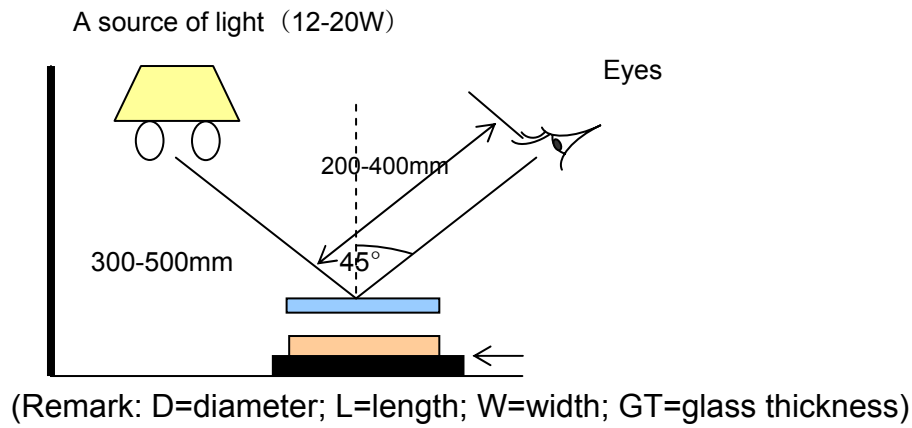

5.3 Visual Area

5.3.1 Scratch

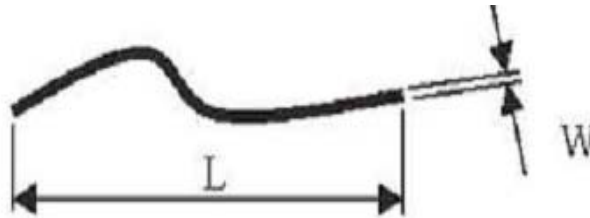

Criteria	Decision
$W < 0.03\text{mm}$	Ignored.
$0.03\text{mm} \leq W \leq 0.05\text{mm}$	$L \leq 3\text{mm}$, two objects are ignored. $5\text{mm} > L > 3\text{mm}$, one objects are ignored.
$W > 0.05\text{mm}$	The T/P is regarded as a defect.

5.3.2 Dot-like Foreign Matter

Criteria	Decision
$D < 0.2\text{mm}$	Ignored.
$0.2\text{mm} \leq D \leq 0.25\text{mm}$	The object is $>10\text{mm}$ in distance from any other foreign object.

	Two objects are allowed.
$0.25\text{mm} \leq D \leq 0.3\text{mm}$	One object is allowed.
$D \geq 0.3\text{mm}$	The T/P is regarded as a defect.

5.3.3 Linear Foreign Matter

Criteria	Decision
$W < 0.05\text{mm}$	$L \leq 2\text{mm}$ Ignored.
$W < 0.05\text{mm}$	$2 < L \leq 3\text{mm}$, the object is $> 10\text{mm}$, two object is ignored.
$W > 0.05\text{mm}$ or $L > 3\text{mm}$	The T/P is regarded as a defect.

5.3.4 OCA bubbles and bend

Criteria	Decision

5.3 Non- visual Area (overlay)

5.4.1 Dot-like Foreign Matter

Criteria	Decision
$W < 2\text{mm}$	Ignored.
$0.2\text{mm} \leq W \leq 0.3\text{mm}$	Two objects are ignored.
$W > 0.3\text{mm}$	The T/P is regarded as a defect.

5.4.2 Chip and Crack

Corner fragment: $X < 2.0\text{mm}$ and $Y < 2.0\text{mm}$ and $Z < \text{GT}$ it is ignored

- 1) Corner fragment in the golden finger that seriously affects the product function is regarded as a defect.
- 2) Corner fragment in the circuit that seriously affects product function is regarded as a defect.

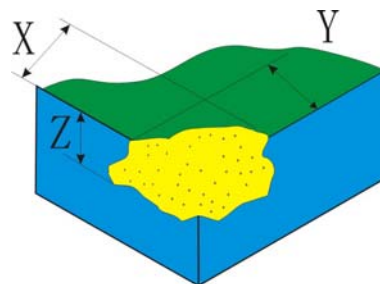

Side fragment: $X < 5.0\text{mm}$ and $Y < 1.0\text{mm}$ and $Z < GT$ it is ignored

- 1) Side fragment in the golden finger that seriously affects the product function is regarded as a defect.
- 2) Side fragment in the circuit that seriously affects product function is regarded as a defect.

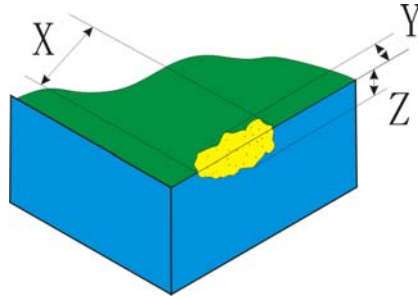

6. Reliability Specification

Item	Specification	Remarks
Operating temperature and humidity	-20~70℃, 20~85% RH	Except for dew gathering
Storage temperature and humidity	-30~80℃, 20~85% RH	Except for dew gathering
Humidity resistance	The requirement in 6 shall be satisfied after exposing at 60℃, 90% RH for 240 hours and at normal temperature and humidity for 24 hours.	Except for dew gathering
Heat resistance	The requirements in 6 shall be satisfied after exposing at 70℃, for 240 hours and at normal temperature and humidity for 24 hours.	Except for dew gathering
Cold resistance	The requirements in 6 shall be satisfied after exposing at -20℃, for 240 hours and at normal temperature and humidity for 24 hours.	Except for dew gathering
Thermal shock	The requirements in 6 shall be satisfied after exposing under the conditions of -30℃(0.5hour)→80℃(0.5hour) by 10 cycles ,and at normal temperature and humidity for 24 hours.	Except for dew gathering
Vibration resistance	The requirements in “Operation force” of the item 3-1 Mechanical .Characteristics and 6 Electric characteristics shall be satisfied after sweep vibration of 20 m/s ² , 10 Hz to 55 Hz (1 min) is given for 30 min. each in the directions of X, Y, Z.	

7. Handling Precautions

Storage

Store the products at the temperature and humidity range presented in the specification.

Store the products in the state of package.

Do not expose the product to a direct ray of the sun.

Unpacking

Do not hold FPC/Copper tail to take out touch panels in the package.

Use gloves and finger coat to prevent stains on the touch panel and injury by the sharp edge of the touch panel.

Do not take hold of FPC /Copper tail when handling the touch panel.

Do not pile up touch panels.

Handling

Do not put anything on the touch panel.

Do not fold the FPC /Copper tail.

Clean off the touch panel with alcohol and soft clothes when necessary

Prevent alcohol from penetrating into the touch panel.

Do not use organic solvents except for alcohol.

Assembly

Avoid excessive force on the touch panel.

Do not give unnecessary strain to the FPC /Copper tail while assembling.

Operation

Do not operate touch panel by applying excessive force.

Do not use a sharp thing for input.

We recommend calibration after long time use.

8. Packing

---TBD----

Part. No	KDCTP030001A	REV	V1.0	Page 15 of 15
----------	--------------	-----	------	---------------